

Panasonic

Operating Instructions AC/Rechargeable Professional Hair Clipper

Model No. ER-HGP84
ER-HGP74

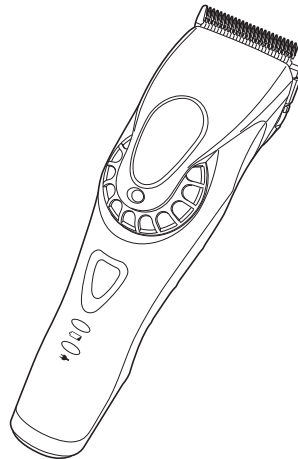

ER-HGP84

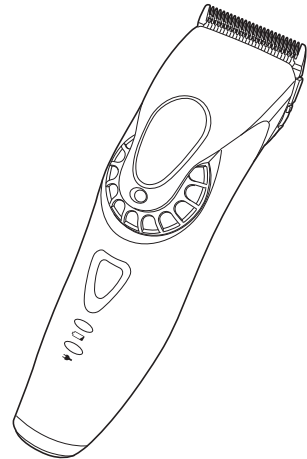

ER-HGP74

Operating Instructions
AC/Rechargeable Professional Hair Clipper

Model No. ER-HGP84
ER-HGP74

Contents

Safety precautions.....	6	Care.....	12
Important information	9	Troubleshooting	14
Parts identification	10	Disposal of the appliance	15
Charging.....	10	Specifications	16
How to use	12		

Thank you for purchasing this Panasonic product.

Before operating this unit, please read these instructions completely and save them for future use.

WARNING

- This appliance can be used by children aged from 8 years and above and persons with reduced physical, sensory or mental capabilities or lack of experience and knowledge if they have been given supervision or instruction concerning use of the appliance in a safe way and understand the hazards involved. Children shall not play with the appliance. Cleaning and user maintenance shall not be made by children without supervision.
- The supply cord cannot be replaced. If the cord is damaged, the AC adaptor should be scrapped.
- Do not use anything other than the supplied AC adaptor and the charging stand for any purpose.
Also, do not use any other product with the supplied AC adaptor and the charging stand. (See page 10.)
- Keep the appliance dry.

- The following symbol indicates that a specific detachable power supply unit is required for connecting the electrical appliance to the supply mains. The type reference of power supply unit is marked near the symbol.





Safety precautions

Make sure to follow these instructions.

To prevent accidents, injuries or damage to property, please follow the instructions below.

■ **The following chart indicates the degree of damage caused by improper operation.**

 **DANGER** Indicates potential hazard that will result in serious injury or death.

 **WARNING** Indicates potential hazard that could result in serious injury or death.

 **CAUTION** Indicates potential hazard that could result in minor injury or property damage.

WARNING

► **Power supply**

- **Do not connect or disconnect the adaptor to a household outlet with a wet hand.**
- Doing so may cause electric shock or injury.

- **Do not immerse the main body, AC adaptor and the charging stand in water or wash it with water.**
- **Do not place the main body, AC adaptor and the charging stand over or near water filled sink or bathtub.**
- **Do not use when the AC adaptor is damaged or when the fitting into the household outlet is loose.**
 - **Do not deface, modify, forcefully bend or pull the cord or the power plug. Also, do not place anything heavy on, twist or pinch the cord.**
- Doing so may cause electric shock or fire due to a short circuit.
- **Do not use in a way exceeding the rating of the household outlet or the wiring.**
- Exceeding the rating by connecting too many plugs to one household outlet may cause fire due to overheating.
- **Always ensure the appliance is operated on an electric power source matched to the rated voltage indicated on the AC adaptor.**
- **Fully insert the adaptor.**
- Failure to do so may cause fire or electric shock.
- **Always unplug the adaptor from a household outlet when cleaning.**
- Failure to do so may cause electric shock or injury.
- **Regularly clean the power plug, the appliance plug and the charging plug to prevent dust from accumulating.**
- Failure to do so may cause fire due to insulation failure caused by humidity.
Disconnect the adaptor and wipe with a dry cloth.

WARNING

- ▶ **In case of an abnormality or malfunction**
- **Immediately stop using and remove the adaptor if there is an abnormality or malfunction.**
 - Failure to do so may cause fire, electric shock, or injury.
- ◀ **Abnormality or malfunction cases**
- **The main body, charging stand or AC adaptor is deformed or abnormally hot.**
- **The main body, charging stand or AC adaptor smells of burning.**
- **There is an abnormal sound during use or charging of the main body.**
 - Immediately request inspection or repair to an authorized service centre.
- ▶ **This appliance**
- **This appliance has a built-in rechargeable battery. Do not throw into fire or apply heat. Do not charge, use or leave in high temperature environment.**
 - Doing so may cause fluid leak, overheating, or explosion.
- **Do not modify or repair.**
 - Doing so may cause fire, electric shock, or injury. Contact an authorized service centre for repair (battery change, etc.).
- **Never disassemble except when disposing of the appliance.**
 - Doing so may cause fire, electric shock, or injury.

▶ Preventing accidents

- **Do not place within reach of children or infants. Do not let them use it.**
 - Putting parts or accessories in the mouth may cause an accident or injury.
- **If the oil is consumed accidentally, do not induce vomiting, drink a large amount of water, and contact a physician.**
- **If the oil comes into contact with eyes, immediately wash thoroughly with running water, and contact a physician.**
 - Failure to do so may result in physical problems.

CAUTION

▶ Protecting the skin

- **Do not press the blade strongly against the skin.**
- **Do not use the appliance for any purpose other than trimming hair.**
- **Do not directly apply the blades on ears or rough skin (such as swellings, injuries or blemishes).**
 - Doing so may cause injury to ears or uneven skin.
- **Check that the blades are not damaged or deformed before use.**
 - Failure to do so may cause skin injury.

⚠ CAUTION**► Note the following precautions**

- **Do not allow metal objects or trash to adhere to the power plug, the appliance plug or the charging plug.**
 - Doing so may cause electric shock or fire due to a short circuit.
- **Do not drop or hit against other objects.**
 - Doing so may cause injury.
- **Do not wrap the cord around the adaptor or the charging stand when storing.**
 - Doing so may cause the wire in the cord to break with the load, and may cause fire due to short circuit.
- **Do not disconnect the power plug or the appliance plug by holding the cord when disconnecting it.**
 - Failure to do so may cause electric shock or injury.
- **Disconnect the adaptor from the household outlet when not using.**
 - Failure to do so may cause electric shock or fire due to electrical leakage resulting from insulation deterioration.

Handling of the removed battery when disposing**⚠ DANGER**

- **The rechargeable battery is exclusively for use with this appliance. Do not use the battery with other appliances.**
- **Do not charge the battery after it has been removed from the appliance.**
- **Do not throw into fire or apply heat.**
- **Do not hit, disassemble, modify, or puncture with a nail.**
- **Do not let the positive and negative terminals of the battery get in contact with each other through metallic objects.**
- **Do not carry or store the battery together with metallic jewellery such as necklaces and hairpins.**
- **Do not use or leave the battery where it will be exposed to high temperatures, such as under direct sunlight or near other sources of heat.**
- **Never peel off the tube.**
 - Doing so may cause overheating, ignition, or explosion.

⚠ WARNING

- **After removing the rechargeable battery, do not keep it within reach of children and infants.**
 - The battery will harm the body if accidentally swallowed.
 - If this happens, consult a physician immediately.

WARNING

- **If the battery fluid leaks out and comes in contact with the eyes, do not rub the eyes, and thoroughly rinse with clean water, such as tap water.**
 - Failure to do so may cause eye injury.
Consult a physician immediately.

CAUTION

- **If the battery fluid leaks out and comes in contact with the skin or clothes, rinse off with clean water, such as tap water.**
 - Failure to do so may cause inflammation.

Important information

- This appliance is designed for professional use to trim hair. It can be operated on either an AC adaptor or rechargeable battery.
- Apply the lubrication oil to the blade before and after each use.
(See page 14.)
Failure to apply the lubrication oil may cause the following problems.
 - The appliance has become blunt.
 - Shorter operating time.
 - Louder sound.
- The appliance may become warm during operation and/or charging. This is normal.
- Do not use any blade other than the one dedicated as it may cause defect in performance.
- You should not allow permanent wave lotion, hair dyeing or hair spray to come into contact with the main body or the blades.
Doing so may result in cracking or corrosion.
- Before using an attachment, check that it has been installed correctly. Failure to do so may cause hair to be cut too short.
- Charge the appliance correctly according to these Operating Instructions. (See page 10 "Charging".)
- This appliance contains battery that is only replaceable by skilled persons. Please contact an authorized service centre for the details of repair.

Parts identification

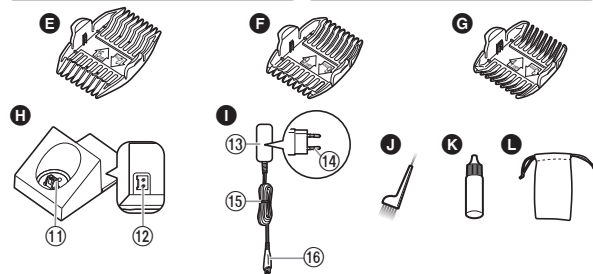
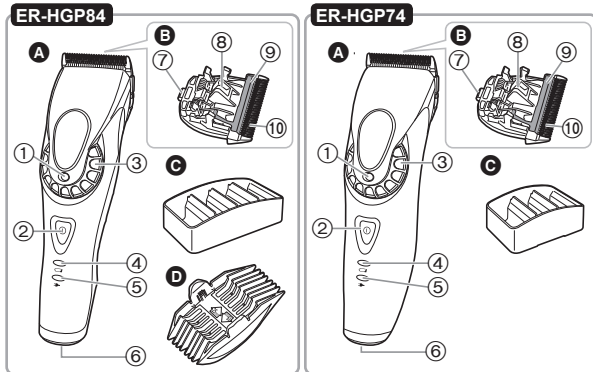

A Main body

- ① Trimming height indicator
- ② Power switch

- ③ Dial (Height adjustment control)
- ④ Recharge lamp (White)

- ⑤ Charge status lamp (Red)
- ⑥ Appliance socket
- B Blade**
 - ⑦ Mounting hook
 - ⑧ Cleaning lever
 - ⑨ Moving blade
 - ⑩ Stationary blade
- C Comb attachment shelves**
- D 19 mm/25 mm comb attachment**
- E 12 mm/15 mm comb attachment**
- F 6 mm/9 mm comb attachment**

- G 3 mm/4 mm comb attachment**
- H Charging stand (RC9-92)**
 - ⑪ Charging plug
 - ⑫ Stand socket
- I AC adaptor (RE9-82)**
 - ⑬ Adaptor
 - ⑭ Power plug
 - ⑮ Cord
 - ⑯ Appliance plug
- Accessories
 - J Cleaning brush**
 - K Lubrication oil**
 - L Pouch**

Charging

(Illustration: ER-HGP84)

- Turn the appliance off.

- 1 Connect the appliance plug to the stand socket.**
- 2 Place the appliance on the charging stand.**
- 3 Insert the adaptor into a household outlet.**
 - Charging is completed after approx. 1 hour.
 - Check the charge status lamp (→) glows.

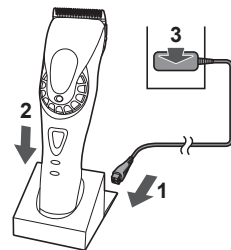

4 Disconnect the power plug after charging is completed.

(For safety and energy saving)

- Charging is required when the recharge lamp blinks.
- The appliance can be used for approximately 5 minutes after the recharge lamp blinks.



While charging

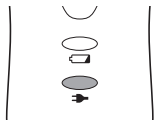

The charge status lamp glows.

After charging is completed

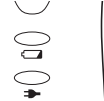

The charge status lamp turns off.

<How to check that charging is completed>

Insert the main body again after removing it from the charging stand.

If the charge status lamp glows and then turns off after 5 seconds, charging is completed.

Notes

- If there is noise from the radio or other sources while using or charging the appliance, move to a different location to use the appliance.
- The battery will deteriorate if not used for over 6 months, so make sure to perform a full charge at least once every 6 months.

- The charging time may differ when charging the main body for the first time, or if it has not been used for more than 6 months. The lamp on the main body may not glow for several minutes when first starting charging, but will glow when continuing to charge.
- Recommended ambient temperature for charging is 10 °C – 35 °C. It may take longer to charge, or the charge status lamp will blink quickly and the battery may fail to charge properly in extremely high or low temperatures.
- 1 full charge will provide approximately 50 minutes of continuous operation. (Based on dry using at 20 °C – 30 °C)
The operating time may differ depending on the frequency of use and the operating method.
- The battery used is a lithium-ion, so charging after every use will have no effect on battery life.
- To keep charging the battery will not affect battery performance.

Charging without the charging stand

1. Connect the appliance plug to the appliance socket.
2. Plug in the adaptor into a household outlet.



AC operation

If you connect the AC adaptor to the appliance in the same way as for charging, and turn on the power, you can use it.

- If the remaining battery is too low, the blades may move slowly or stop, even with the AC operation. In this case, charge the battery for 1 minute or more.
- The battery will be discharged, even with the AC operation.

How to use

(Illustration: ER-HGP84)

- Check that the blades are not damaged or deformed before use.
- Turn the appliance off.
- Apply the lubrication oil to the blade before and after each use. (See page 14.)
- The appliance may not operate in an ambient temperature lower than approximately 5 °C.

1 Set the trimming height.

2 Press the power switch to turn on the appliance.

Setting the trimming height

For a trimming height of 0.8 mm to 2.0 mm, turn the dial to the desired height.

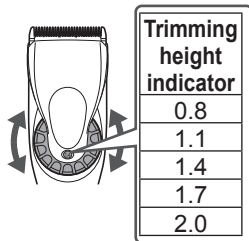

Use an attachment for a trimming height higher than 3 mm or more.

Removing and mounting the comb attachments

► Mounting the attachment

1. Select the trimming heights indicated on the insides and sides of the attachments.
2. Set the dial to "0.8" and then mount the attachment to the main body as illustrated.

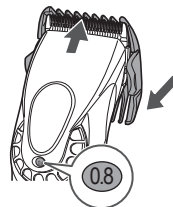

► Removing the attachment

Slide one side of the attachment off the mounting in direction indicated with the arrow.

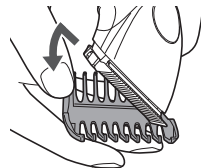

Care

(Illustration: ER-HGP84)

Removing and mounting the blade

- Turn the appliance off.

► Removing the blade

Hold the main body with the switch facing upward and push the blade with your thumb while catching the blade in your other hand.



► Mounting the blade

1. Set the dial to "2.0".

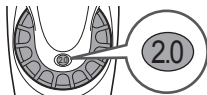

2. Fit the mounting hook into the blade mounting on the main body and push in until it clicks.

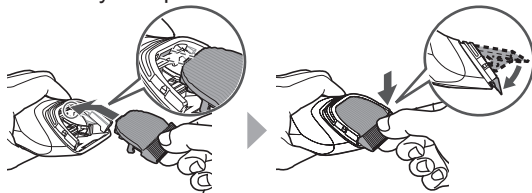

Cleaning

- Clean the main body, blade and the attachment after each use.
(If not cleaned, the motion will become poor and the sharpness will worsen.)
- Turn the appliance off.
- Do not use thinner, benzene, alcohol or other chemicals. Doing so may cause failure, cracking or discoloration of the main body. Clean the main body only with a soft cloth slightly dampened with tap water or soapy tap water.



The symbol on the left means "Do not wash the product with water".

► Blade

1. Brush off any hairs from the main body and from around the blade.

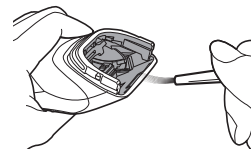

2. Brush off the hairs from the blade edge.

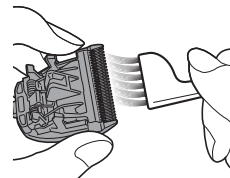

3. Brush any hair trimmings out from between the stationary blade and the moving blade while pressing down the cleaning lever (a) to raise the moving blade.

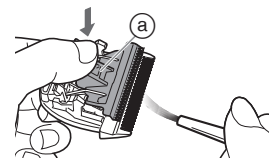

► Charging stand

Use the cleaning brush to clean hair trimmings and dust in the charging plug or in the hole on the bottom surface.

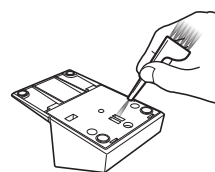
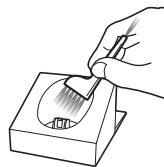

Lubrication

- Apply the lubrication oil to the blade before and after each use.

- 1 Remove the blade.**
(See page 12.)
- 2 Apply a drop of the lubrication oil to each indicated point.**
- 3 Attach the blade to the main body, turn on the power and allow to run for approximately 5 seconds.**

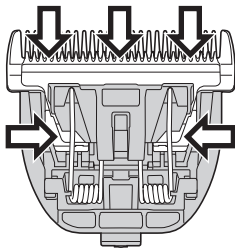

► Replacement parts

Replacement part is available at your dealer or Service Centre.

Replacement parts for ER-HGP84/ER-HGP74	Blade	WER9920
	Lubrication oil	WES003P

- Using other than recommended genuine blade, any warranty claim will expire.
- We recommend Panasonic lubrication oil WES003P.

Troubleshooting

Problem	Action
The appliance has become blunt.	Until problems are solved, please follow each procedure as follows;
Operating time is short.	<ol style="list-style-type: none"> 1. Charge the appliance. (See page 10.) 2. Clean the blade and apply lubrication oil. (See pages 13 and 14.)
Appliance stopped functioning.	<ol style="list-style-type: none"> 3. Replace the blade. (See pages 12 and 14.) 4. Have the battery replaced by an authorized service centre.
The appliance cannot be charged.	<ol style="list-style-type: none"> ► Push the main body into the charging stand or appliance plug all the way. ► Charge within the recommended charging temperature of 10 °C to 35 °C.
Makes a loud sound.	<ol style="list-style-type: none"> ► Apply lubrication oil. (See this page.) ► Confirm that the blade is properly attached.

If the problems still cannot be solved, contact your dealer or a service centre authorized by Panasonic for repair.

Disposal of the appliance

Remove the built-in rechargeable battery before disposing the appliance.

- The battery is to be disposed of safely.
- This figure must only be used when disposing the appliance, and must not be used to repair it. If you dismantle the appliance yourself, it may cause malfunction.

How to remove the battery

- Remove the appliance from the AC adaptor.
- Press the power switch to turn on the power and then keep the power on until the battery is completely discharged.
- Perform following steps and lift the battery, and then remove it.
- Take care not to short circuit the positive and negative terminals of the removed battery, and insulate the terminals by applying tape to them.

For environmental protection and recycling of materials

This appliance contains a Lithium-ion battery. Please make sure that the battery is disposed of at an officially assigned location, if there is one in your country.

► ER-HGP84

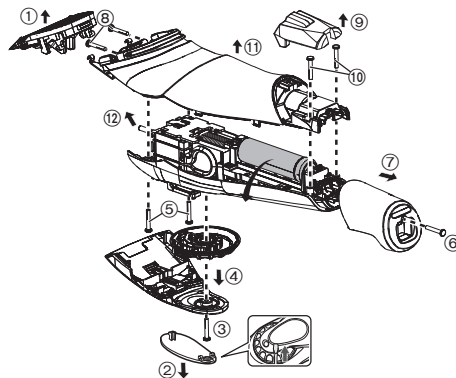

► ER-HGP74

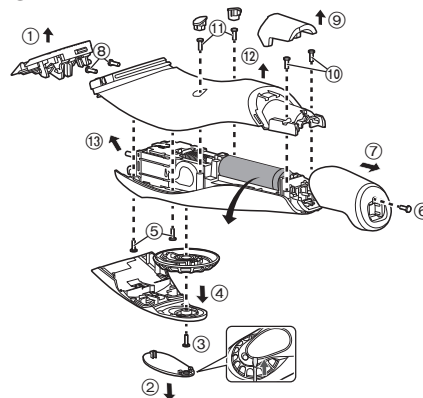

Specifications

Power source	See the name plate on the AC adaptor. (Automatic voltage conversion)
Motor voltage	3.6 V \equiv
Charging time	Approx. 1 hour

For more information about the energy efficiency of the product, please visit our website, www.panasonic.com, and enter the model number in the search box.

Disposal of Old Equipment and Batteries Only for European Union and countries with recycling systems



These symbols on the products, packaging, and/or accompanying documents mean that used electrical and electronic products and batteries must not be mixed with general household waste.

For proper treatment, recovery and recycling of old products and batteries, please take them to applicable collection points in accordance with your national legislation.

By disposing of them correctly, you will help to save valuable resources and prevent any potential negative effects on human health and the environment.

For more information about collection and recycling, please contact your local authority.

Penalties may be applicable for incorrect disposal of this waste, in accordance with national legislation.



Note for the battery symbol (bottom symbol)

This symbol might be used in combination with a chemical symbol. In this case it complies with the requirement set by the Directive for the chemical involved.

Panasonic Corporation
<http://www.panasonic.com>
© Panasonic Corporation 2021